

第二学年数学期考二

姓名: _____ () 评分: _____

班级: 2 ()

日期: ____ / ____ / 2012

家长签阅: _____

A. 仔细阅读后, 把正确的答案填在空格里。10×2%=20%

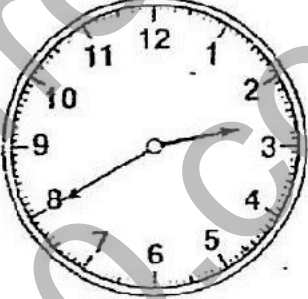
1.	<p>图 1 显示一个钟面。</p>  <p>图 1</p> <p>图 1 钟面显示的时刻是</p> <p>A 1: 40 C 2: 08 B 1: 45 D 2: 40</p>	
2.	<p>4 时 20 分 =</p> <p>A 0:42 C 4:20 B 4:02 D 42:00</p>	

6.

图3显示四种物体的长度。

钢笔

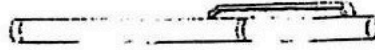

铅笔

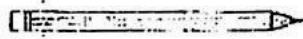

粉笔

铁钉



图3

最长与最短的物体分别是

	最长的物体	最短的物体
A	铅笔	铁钉
B	铁钉	钢笔
C	钢笔	粉笔
D	铅笔	粉笔

7.

下列哪项是正确的?

- A 3克 = 3g
- B 10克 = 100 kg
- C 5公斤 = 50 kg
- D 8公斤 = 80 kg

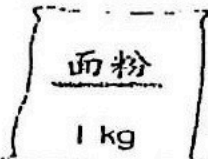
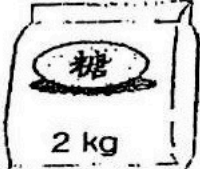
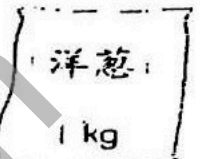
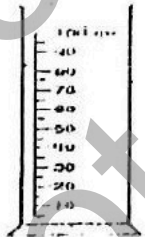
8.	<p>下列哪个物体最重?</p> <p>A  1 kg</p> <p>B  面粉 1 kg</p> <p>C  糖 2 kg</p> <p>D  洋葱 1 kg</p>	
9.	<p>鲜奶的体积是 80ml。它的体积等于 _____。</p> <p>A 0.8 毫升 C 800 毫升 B 8 毫升 D 80 毫升</p>	
10.	<p>图 4 显示一个量筒水里的体积。 量筒里水的体积是多少毫升?</p> <p></p> <p>图 4</p> <p>A 20 C 60 B 40 D 80</p>	

B. 看钟面, 写分钟。 $11 \times 2\% = 22\%$

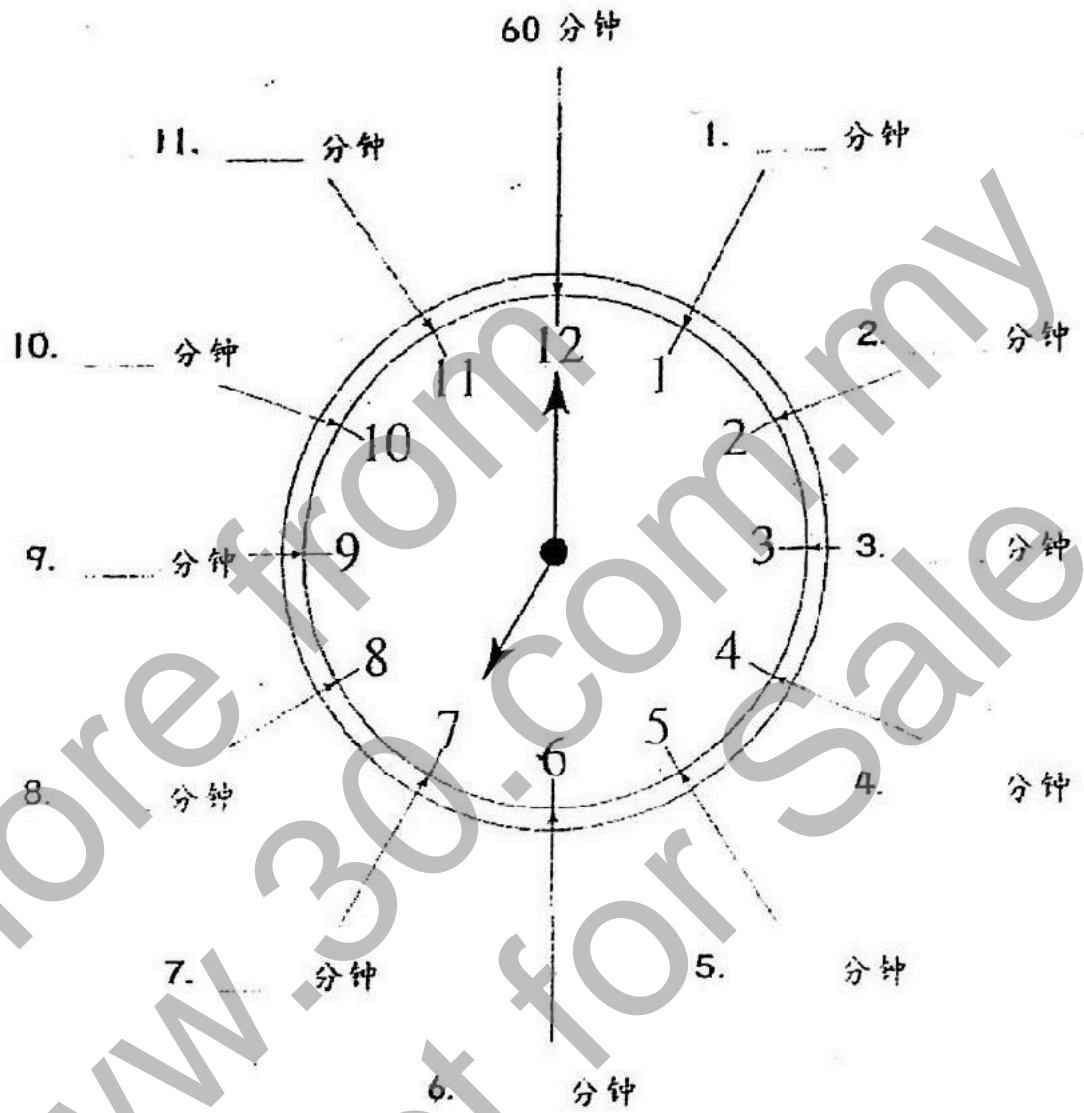

/ MATEMATIK / TAHUN 2 / OKTOBER / MUKA SURAT 5

C. 以数字和文字写出时刻。5×2%=10%

例

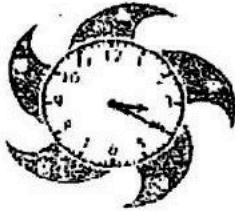

3:20

三时二十分

a

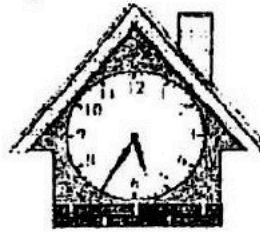

b

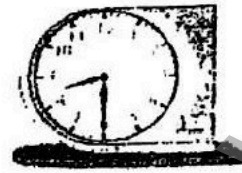

c

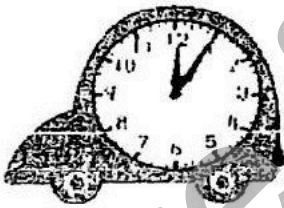

d



e

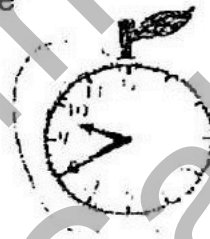

D. 把正确的答案涂上颜色。6×2%=12%

1.	4 厘米 =	4m	4cm	4.	2 公斤 =	2kg	2g
2.	12 米 =	12m	12cm	5.	300ml =	30 升	300 毫升
3.	100g =	100 公斤	100 克	6.	7 升 =	7 ml	7 l

E. 填写正确的答案。5×2%=10%

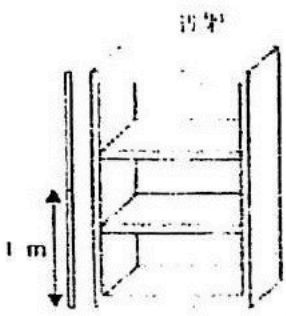
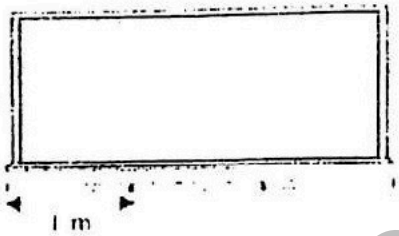
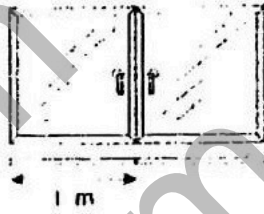
  
1) 书架的高度是 () 米。
2) 黑板的长度是 () m。
3) 窗的长度是 () 米。
4) () 的高度和 () 的长度一样。

F. 记录以下物体的质量。6×2%=12%

1

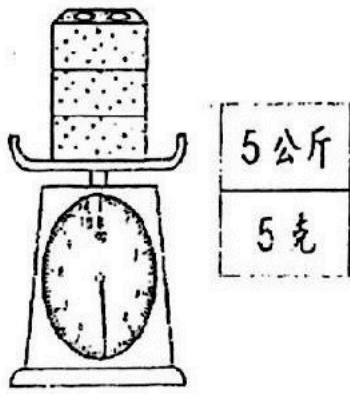

2

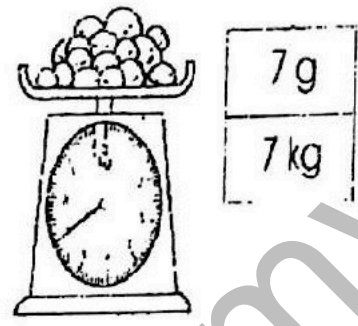

3

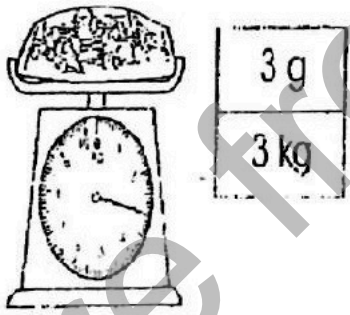

4

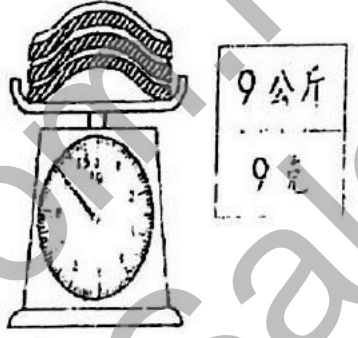

5

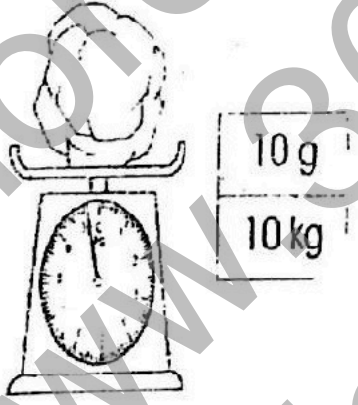

6

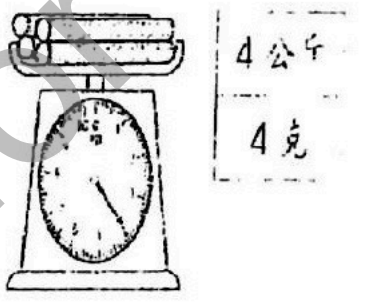

G. 根据容器里液体的体积, 圈出正确的答案。4×2%=8%

1



100 ml

1 升

3

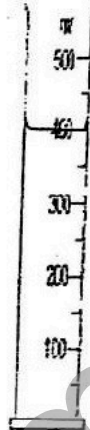

4 升

400 ml

2

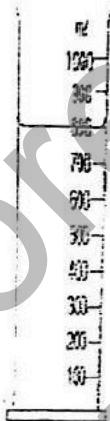

8 l

800 毫升

4

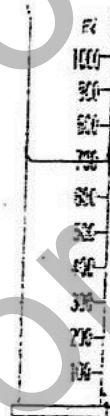

700 毫升

7 l

H. 写出液体的体积。3×2%=6%

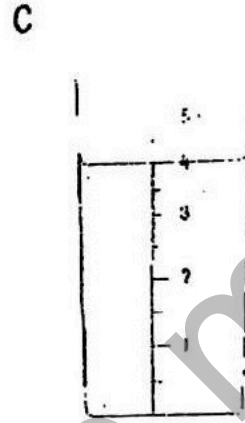
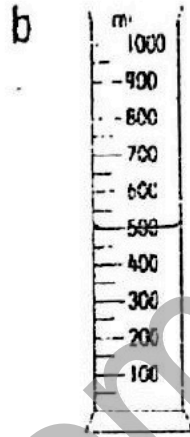
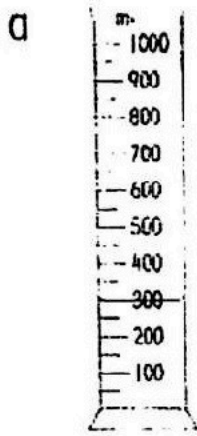

第二学期数学期考二的答案

A.

1. D	2. C	3. B	4. A	5. B	6. C	7. A	8. C	9. D	10. D
------	------	------	------	------	------	------	------	------	-------

B.

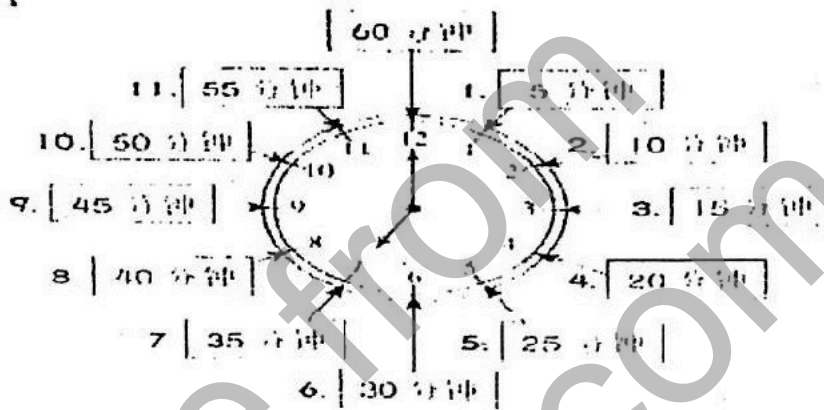

C.

- | | |
|--------------------|----------------------|
| (a) 5:35
五时三十五分 | (b) 8:30
八时三十分 |
| (c) 12:05
十二时五分 | (d) 11:55
十一时五十五分 |
| (e) 9:40
九时四十分 | |

D.

1.	4 厘米 =	4m		4.	2 公斤 =		2g
2.	12 米 =		12cm	5.	300m ℓ =	30 升	
3.	100g =	100 公斤		6.	7 升 =	7 m ℓ	

E.

- 2 米
- 3 米
- 2 米

- 3 m
- 书架, 窗

F.

- 5 公斤
- 9 公斤
- 100

- 7 kg
- 10 kg

- 3 kg
- 4 公斤

G.

1. 100 m ℓ	2. 800 毫升	3. 400 m ℓ	4. 700 毫升
------------	-----------	------------	-----------

H.

- (a) 300 (b) 500 (c) 4

《小作家课程》教你实用的写作技巧, 让你轻松面对考试!
只需一次付费, 即可使用长达三年! 而且内容会持续更新, 不另加收费!
点击这里购买完整版: <https://30.com.my/bc2>
或者免费注册体验版: <https://class.30.com.my/courses/bc2-trial>

